

MODIFIED SPECIAL NOTE FOR FULL DEPTH CONCRETE PAVEMENT REPAIR

This Special Note applies to full depth repairs of concrete pavement. Section references herein are to the Department's Standard Specifications for Road and Bridge Construction, current edition.

1.0 DESCRIPTION. Remove and replace concrete pavement. Comply with the applicable Standard Drawings and the Standard Specifications except as specifically superseded herein.

2.0 MATERIALS AND EQUIPMENT.

2.1 JPC Pavement. Test concrete materials according to section 601.03.03. Conform to 501, 502, and 601 except that the concrete must achieve 3000 psi in accordance with Section 4.4 of this note. The Engineer may allow pavement to be opened to traffic at less than 3,000 psi subject to the deductions described in Section 4.3 of this note.

2.2 Dowel Bars and Sleeves. Conform to 811. Contrary to the Standard drawings, 1.5-inch diameter dowel bars will be accepted for 13-inch JPC Pavement and 1.5-inch diameter dowel bars will be required for 10-inch JPC Pavement.

2.3 Tie Bars. Conform to Section 811. Use epoxy coated tie bars in longitudinal and transverse joints.

2.4 Joint Sealants. Conform to Subsection 807.03.01 or 807.03.05.

2.5 Grout Adhesives and Epoxy Resin Systems. Conform to Section 826.

2.6 Dense Graded Aggregate (DGA) and Crushed Stone Base (CSB). Conform to Section 805.

2.7 Geotextile Fabric. Conform to Section 843 and Special Note for Class 4A Geotextile Fabrics.

2.8 Drills. Drill holes using a gang drill, capable of drilling a minimum of four simultaneously. Misalignment of holes shall not exceed 1/4 inch in the vertical or oblique plane.

2.9 Hammers. Only use chisel point hammers weighing less than 40 pounds to remove deteriorated concrete.

3.0 CONSTRUCTION.

3.1 Removal of Existing Pavement. Remove existing pavement to the extent the Contract specifies or as the Engineer directs. The minimum length of patches measured along centerline is 3 feet on each side of an existing joint.

When working with pavements with non-skewed transverse joints, if it is necessary to remove existing pavement closer than 6 feet to a transverse joint, remove the pavement 3 feet beyond that joint .

When working with pavements with skewed transverse joints, if it is necessary to remove existing pavement closer than 3 feet to a transverse joint, remove the pavement 3 feet beyond that joint.

Details of configurations of pavement and joints for various situations are

depicted in the drawings herein.

When small areas of removal and replacement are performed at bridge ends, maintain or reconstruct existing expansion joints at their existing location. When the Engineer determines extensive full width removal and replacement is required, construct new expansion joints at the locations shown on Standard Drawing No. RPN-010.

In the removal operation, make a full depth saw cut longitudinally along the centerline joint and shoulder joint and transversely along the area marked for removal. To prevent damage to the subbase, do not allow the saw to penetrate more than $\frac{1}{2}$ " into the subbase. The Engineer may direct or approve additional cuts within the removal area in order to prevent damage to adjacent pavement remaining in place. Do not overcut beyond the limits of the removal area. Prevent saw slurry from entering existing joints and cracks. To avoid pumping and erosion beneath the slab, do not allow traffic on sawed pavement, unless directed by the Engineer.

Lift out the deteriorated concrete vertically with lift pins. If approved by the Engineer, use other methods that do not damage the base, shoulder, or sides of pavement that is to be left in place. If any damage does occur, saw cut and remove damaged section and if necessary use an acceptable alternative method for the removal process. Any additional costs associated with repair shall be the contractor's responsibility. Do not damage the pavement base during these operations.

Dispose of all removed pavement, cuttings, debris, and other waste off the right-of-way at approved sites obtained by the Contractor at no additional cost to the Department. The Contractor will be responsible for obtaining any necessary permits for this work.

3.2 Pavement Replacement. Do not damage the pavement base during these operations.

3.2.1 Preparation of Base. Compact the new and existing aggregate base to the Engineer's satisfaction. The Engineer will accept compaction by either visual inspection or by nuclear gauge. When the Engineer deems it necessary to stabilize the existing base or replace unsuitable materials, excluding bridge ends, use additional DGA to the depth deemed necessary by the Engineer. Underlay the DGA with FABRIC-GEOTEXTILE CLASS 4A. Flowable fill and cement stabilization may be used as an alternative to stabilize the existing base or to replace unsuitable materials when a plan for such is presented to and approved by the Engineer. At bridge ends, treat existing base and subgrade as the Contract specifies. During compaction, wet the base as the Engineer directs. Compact areas not accessible to compaction equipment by hand tamping.

3.2.2 Underdrains. Construct, or repair damage to, pavement edge drains according to Section 704. If underdrains are placed omitting areas to be patched, construct additional lateral drains as necessary to provide outlets for the installed underdrain until performing the pavement replacement and completing the underdrain system. Provide drainage for any undercut or base repair areas.

3.2.3 Pavement Replacement. Using load transfer assemblies for dowel joints drill into the existing slab according to the details shown herein and on the Standard Drawings.

Use plain epoxy coated dowels of the size specified on the standard drawings based on the pavement thickness for contraction and expansion joints.

Drill holes for dowel bars and tie bars into the face of the existing slab, at a

diameter as specified in the following. Drill the dowel bar holes and tie bar holes to a depth equal to 1/2 the length of the bars. Anchor tie bars into the existing pavement using an epoxy resin. Anchor dowel bars into the existing pavement using either an epoxy resin or an adhesive grout. For tie bars and dowel bars where an epoxy resin is to be used drill the holes 1/8 inch larger than the bar diameter. For dowel bars where an adhesive grout product is to be used, drill holes 1/4 inch larger than the bar diameter. Use a clear or opaque grout retention disk in both grout and epoxy applications. Operate the equipment to prevent damage to the pavement being drilled. Obtain the Engineer's approval of the drilling procedure. Install load transfer assemblies according to the Standard Drawings and Standard Specifications.

When indicated herein or in the Standard Drawings, use 1 inch deformed tie bars that are 18 inches long placed 30 inches on center starting and ending 20 inches inside the edges of the repair area in the longitudinal joint. Use 1 inch deformed tie bars, or plain epoxy coated dowel bars sized in accordance with the Standard Drawings that are 18 inches long beginning 12 inches inside of each edge and on 12-inch centers in transverse construction joints.

Install the dowels and tie bars according to Section 511 unless contradicted here. Ensure the holes are dry and free of dust and debris. Use a nozzle to insert the grout or epoxy starting at the back of the drilled hole to allow for full coating of the dowel or tie bar. After placement, use a bond breaker on the section of the dowel bar that is protruding from the hole.

Mix, place, finish, and cure concrete according to Section 501 with the exception that the Department will allow truck mixing, 2-bag mixers, and hand finishing.

When required, use a form on the side of the slab at longitudinal joints. When the adjacent traffic lane is not closed to traffic or the drop-off is not protected, temporarily fill the space between the form and the adjacent pavement with DGA. After placing the slab, remove the DGA and form. Fill the hole with concrete and thoroughly consolidate by rodding, spading, and sufficient vibration to form a dense homogeneous mass. Use a form on the side of the slab adjacent to shoulders. Excavate and backfill as shown on Section F'-F'.

For patches less than 25 feet in length, use a bond breaker and do not install tie bars at the longitudinal joint. Bond breakers should not exceed 1/8 inch in thickness, e.g. tarpaper.

When resurfacing is required, a float finish is satisfactory. Otherwise, broom finish or, when the adjacent surface has a grooved finish, texture the surface according to Subsection 501.03.13 H). Finish the surface, including joints, to meet a surface tolerance of 1/8 inch in 10 feet that will be verified by straightedge. Cure the pavement and apply curing membranes according to 501.03.15.

Keep all pavement surfaces adjacent to this operation reasonably clean of excess grout and other materials at all times. Maintain all original longitudinal joints. Place transverse joints according to the details shown herein and on the Standard Drawings.

3.3 Joint Sealing. Seal all new or partially new joints with hot-poured elastic joint sealant according to Subsection 501.03.18.

4.0 MEASUREMENT.

4.1 Remove JPC Pavement. The Department will measure the quantity in square yards of surface area. The Department will not measure removal of underlying

base material for payment and will consider it incidental to Remove JPC Pavement.

No separate payment will be made for the disposal of waste from the project or obtaining the necessary permits but will be incidental to the other items of the work.

4.2 DGA or CSB. The Department will measure the quantity used to stabilize the existing base or to replace unsuitable material in tons. The Department will not measure removal of existing base material or underlying material for payment and will consider incidental to DGA or CSB. The quantity of DGA used for the drop-off protection shall be incidental to this work and will not be measured for payment.

4.3 JPC Pavement Non-Reinforced. The Department will measure according to 501.04.01. The Department will not measure dowels, tie bars, or joint sealing for payment and will consider it incidental to Non-Reinforced JPC Pavement.

JPC Pavement will be paid according to section 5.0 below and according to the following payment schedule based on the compressive strength. The cylinders for payment will be tested two hours prior the scheduled opening of traffic.

3000 psi and up	100% payment
2750 to 3000 psi	75% payment and approval from the Engineer to open to traffic*
2500 to 2750 psi	50% payment and approval from the Engineer to open to traffic*
2250 to 2500 psi	25% payment and approval from the Engineer to open to traffic*
Below 2250 psi	10% payment and no potential to open to traffic. Maintain traffic closure until concrete reaches a minimum of 2250 psi.

*If the Engineer approves opening to traffic, the Engineer will evaluate the concrete at 28 days (or sooner) to determine if the removal and replacement of the concrete is necessary due to pavement distress induced by the early opening (i.e. noticeable cracking). If required by the Engineer, remove and replace those slabs showing distress at no cost to the Department.

4.4 Underdrains. The Department will measure the quantity according to Subsection 704.04. The Department will not measure lateral drains for payment and will consider them incidental to the Underdrains.

5.0 PAYMENT. The Department will consider payment as full compensation for all work required in this provision. The Department will make payment for the completed and accepted quantities under the following:

<u>Code</u>	<u>Pay Item</u>	<u>Pay Unit</u>
02091	Remove Pavement	Square Yard
00001	DGA Base	Ton
02069-02088	JPC Pavement	Square Yard
02608	Fabric-Geotextile Class 4A	Square Yard

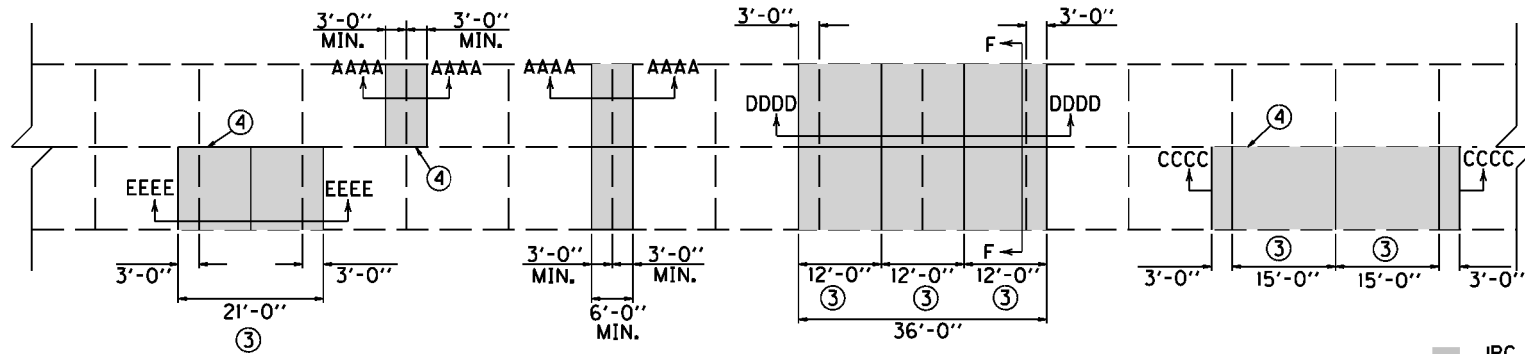

■ JPC PAVEMENT TO BE REMOVED

PLAN VIEW

1. SAW AT LOCATIONS "J" AND ALONG LONGITUDINAL JOINT (IF ONLY ONE LANE IS REMOVED) FULL DEPTH WITHOUT DAMAGE TO EXISTING CONCRETE. SAW RELIEF JOINTS AS THE ENGINEER DIRECTS OR APPROVES. REMOVE THE EXISTING JPC PAVEMENT TO THE LENGTH AND AT THE LOCATIONS NOTED ELSEWHERE IN THE CONTRACT. L=6 FEET MINIMUM AND LOCATIONS "J" SHALL NOT BE CLOSER THAN 6 FEET TO ANY TRANSVERSE JOINT BEYOND THE REPAIR.
2. INSTALL SMOOTH, LOAD TRANSFER DOWELS (EXCEPT USE TIE BARS FOR SECTION CCCC), 18 INCHES LONG (SEE STANDARD DRAWING NO. RPS-020 FOR DOWEL SIZE) AT LOCATIONS "J". INSTALL DOWELS (OR TIE BARS FOR SECTION CCCC) IN THE EXISTING CONCRETE USING EPOXY TYPE IV. INSTALL DOWELS (OR TIE BARS FOR SECTION CCCC) ON 12 INCH CENTERS BEGINNING 12 INCHES FROM THE EDGE OF THE SLAB.
- ③ IF L IS GREATER THAN 20 FEET, INSTALL NEW LOAD TRANSFER ASSEMBLY(S) AND CONSTRUCT CONTRACTION JOINTS SUCH THAT THE DISTANCE BETWEEN JOINTS IN THE REPLACED SECTION IS NO LESS THAN 10 FEET OR MORE THAN 20 FEET. TRANSVERSE JOINTS SHALL BE SPACED APPROXIMATELY 15' EQUIDISTANT, BUT NOT LESS THAN 10 FEET OR NO MORE THAN 20 FEET. ADJUST JOINTS TO PROVIDE THE MINIMUM NUMBER OF JOINTS WITHOUT EXCEEDING THE 10-20 FOOT RANGE. INSTALL NEW LOAD TRANSFER ASSEMBLY(S) AND ALIGN LOAD TRANSFER ASSEMBLY(S) WITH AN EXISTING JOINT OR CRACK IN THE ADJACENT SLAB IF ONLY ONE LANE IS BEING REPLACED.
- ④ IF ONLY ONE LANE IS REMOVED, AND $L > 25'$, INSTALL NEW 1-INCH TIE BARS 18 INCHES LONG ON 30 INCH CENTERS IN THE LONGITUDINAL JOINT USING EPOXY TYPE IV. IF 2 OR MORE LANES ARE REMOVED, CONSTRUCT LONGITUDINAL JOINT(S) ACCORDING TO THE STANDARD DRAWING EXCEPT USE 1-INCH TIE BARS 18 INCHES LONG ON 30 INCH CENTERS. IF $L \leq 25'$, DO NOT TIE THE LONGITUDINAL JOINT TO THE EXISTING LANE; USE A BOND BREAKER MATERIAL APPROVED BY THE ENGINEER THAT WILL ASSURE NO INTERACTION WITH THE ADJACENT LANE.
5. REPLACE WITH NON-REINFORCED JPC PAVEMENT AND INSTALL CONTRACTION JOINTS AT LOCATIONS "K" AND CONTRACTION JOINTS (OR A CONSTRUCTION JOINT FOR LOCATION CCCC) AT LOCATIONS "J". SAW AND SEAL ALL JOINTS.
6. SEE "CROSS SECTION" FOR SECTION F.

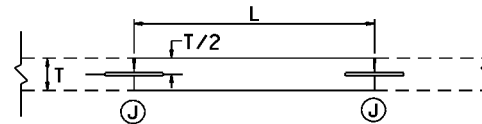

SECTION AAAA
JOINT REPLACEMENT

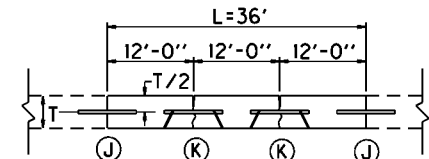

SECTION DDDD
FULL WIDTH REPLACEMENT
(INCLUDING JPC SHOULDERS)

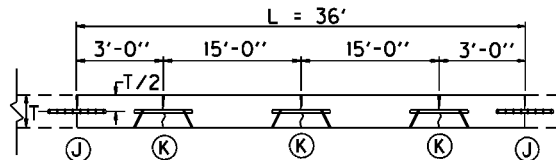

SECTION CCCC
LANE REPLACEMENT WHERE ADJACENT
LANES OR JPC SHOULDERS WILL REMAIN

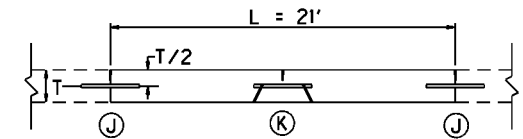

SECTION EEEE
LANE REPLACEMENT $L \leq 25'$

KENTUCKY
DEPARTMENT OF HIGHWAYS

15' JOINT SPACING

APPROVED _____
TECH DIVISION OF DESIGN _____ DATE _____

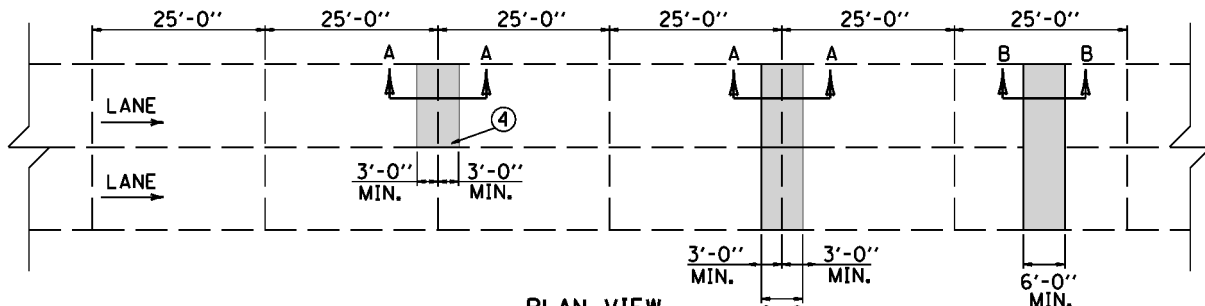

PLAN VIEW

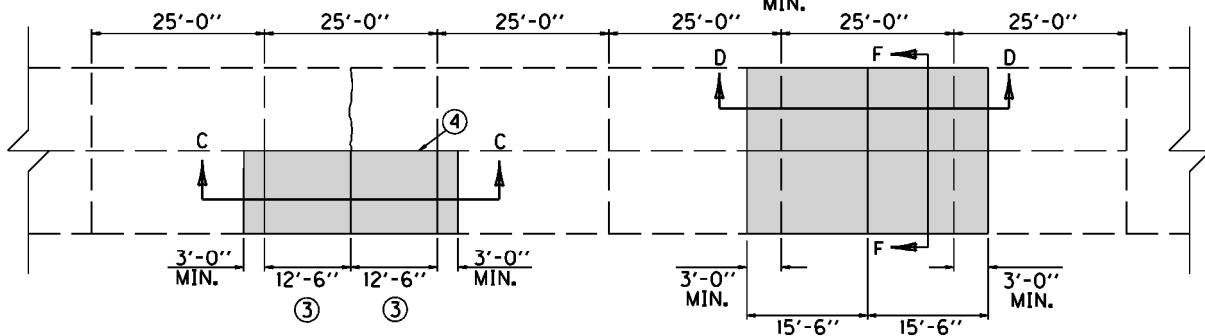

PLAN VIEW

■ JPC PAVEMENT TO BE REMOVED

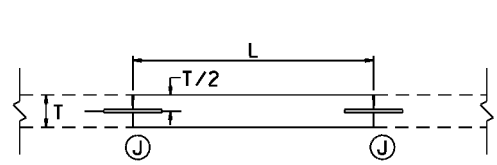

SECTION A
JOINT REPLACEMENT

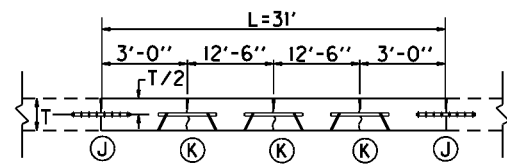

SECTION C
LANE REPLACEMENT WHERE ADJACENT
LANES OR JPC SHOULDERS WILL REMAIN

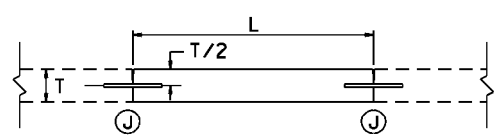

SECTION B
MID-SLAB REPLACEMENT

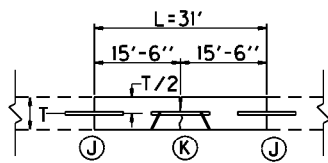

SECTION D
FULL WIDTH REPLACEMENT
(INCLUDING JPC SHOULDERS)

1. SAW AT LOCATIONS "J" AND ALONG LONGITUDINAL JOINT (IF ONLY ONE LANE IS REMOVED) FULL DEPTH WITHOUT DAMAGE TO EXISTING CONCRETE. SAW RELIEF JOINTS AS THE ENGINEER DIRECTS OR APPROVES. REMOVE THE EXISTING JPC PAVEMENT TO THE LENGTH AND AT THE LOCATIONS NOTED ELSEWHERE IN THE CONTRACT. L=6 FEET MINIMUM AND LOCATIONS "J" SHALL NOT BE CLOSER THAN 6 FEET TO ANY TRANSVERSE JOINT BEYOND THE REPAIR.
2. INSTALL SMOOTH, LOAD TRANSFER DOWELS (EXCEPT USE TIE BARS FOR SECTION C), 18 INCHES LONG (SEE STANDARD DRAWING NO. RPS-020 FOR DOWEL SIZE) AT LOCATIONS "J". INSTALL DOWELS (OR TIE BARS FOR SECTION C) IN THE EXISTING CONCRETE USING EPOXY TYPE IV. INSTALL DOWELS (OR TIE BARS FOR SECTION C) ON 12 INCH CENTERS BEGINNING 12 INCHES FROM THE EDGE OF THE SLAB.
- ③ IF L IS GREATER THAN 20 FEET, INSTALL NEW LOAD TRANSFER ASSEMBLY(S) AND CONSTRUCT CONTRACTION JOINTS SUCH THAT THE DISTANCE BETWEEN JOINTS IN THE REPLACED SECTION IS NO LESS THAN 10 FEET OR MORE THAN 20 FEET. TRANSVERSE JOINTS SHALL BE SPACED APPROXIMATELY 15' EQUIDISTANT, BUT NOT LESS THAN 10 FEET OR NO MORE THAN 20 FEET. ADJUST JOINTS TO PROVIDE THE MINIMUM NUMBER OF JOINTS WITHOUT EXCEEDING THE 10-20 FOOT RANGE. INSTALL NEW LOAD TRANSFER ASSEMBLY(S) AND ALIGN LOAD TRANSFER ASSEMBLY(S) WITH AN EXISTING JOINT OR CRACK IN THE ADJACENT SLAB IF ONLY ONE LANE IS BEING REPLACED.
- ④ IF ONLY ONE LANE IS REMOVED, AND L>25', INSTALL NEW 1-INCH TIE BARS 18 INCHES LONG ON 30 INCH CENTERS IN THE LONGITUDINAL JOINT USING EPOXY TYPE IV. IF 2 OR MORE LANES ARE REMOVED, CONSTRUCT LONGITUDINAL JOINT(S) ACCORDING TO THE STANDARD DRAWING EXCEPT USE 1-INCH TIE BARS 18 INCHES LONG ON 30 INCH CENTERS. IF L<25', DO NOT TIE THE LONGITUDINAL JOINT TO THE EXISTING LANE; USE A BOND BREAKER MATERIAL APPROVED BY THE ENGINEER THAT WILL ASSURE NO INTERACTION WITH THE ADJACENT LANE.
5. REPLACE WITH NON-REINFORCED JPC PAVEMENT AND INSTALL CONTRACTION JOINTS AT LOCATIONS "K" AND CONTRACTION JOINTS (OR A CONTRACTION JOINT FOR LOCATION C) AT LOCATIONS "J". SAW AND SEAL ALL JOINTS.
6. SEE "CROSS SECTION" FOR SECTION F.

KENTUCKY DEPARTMENT OF HIGHWAYS
25' JOINT SPACING
APPROVED _____ TEBM DIVISION OF DESIGN DATE _____

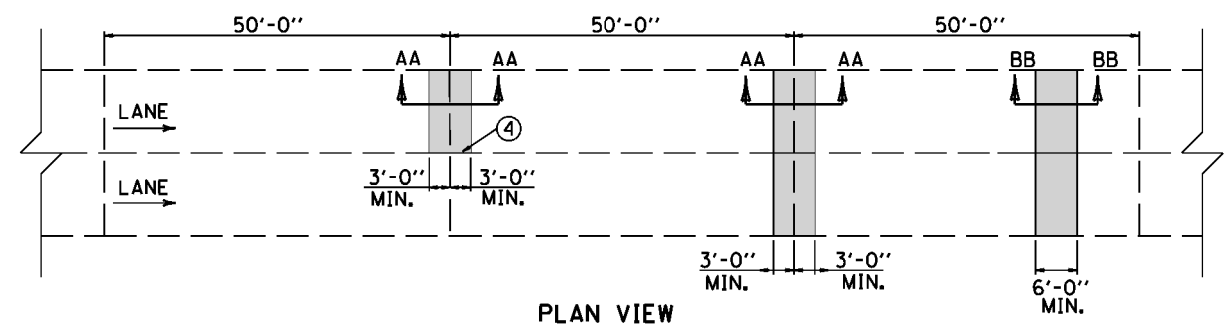

PLAN VIEW

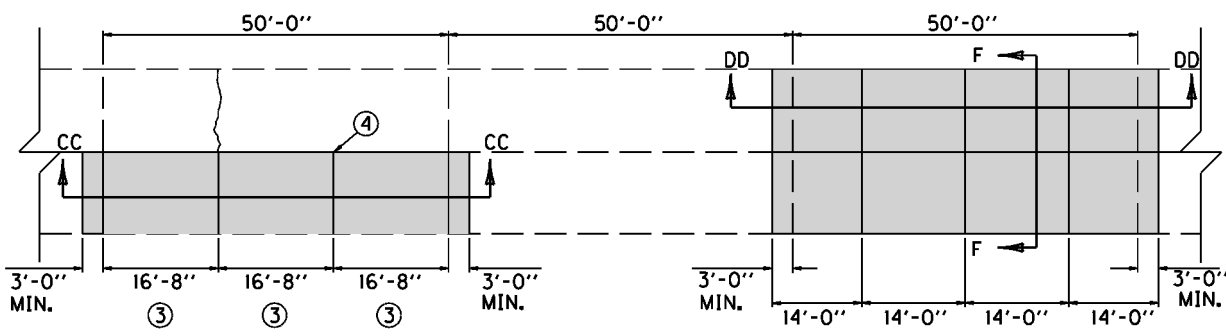

PLAN VIEW

■ JPC PAVEMENT TO BE REMOVED

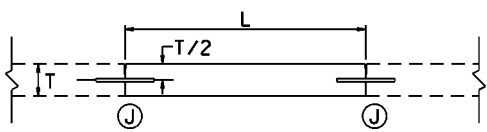

SECTION AA
JOINT REPLACEMENT

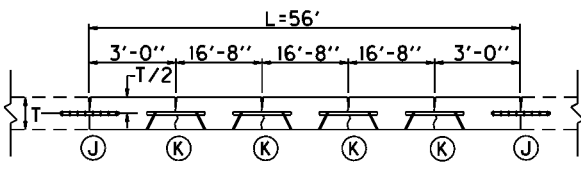

SECTION CC
LANE REPLACEMENT WHERE ADJACENT
LANES OR JPC SHOULDERS WILL REMAIN

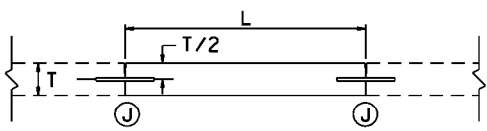

SECTION BB
MID-SLAB REPLACEMENT

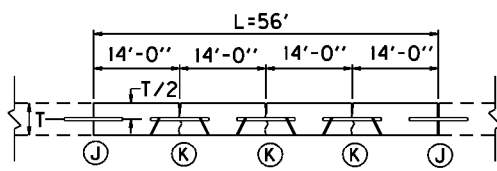

SECTION DD
FULL WIDTH REPLACEMENT
(INCLUDING JPC SHOULDERS)

1. SAW AT LOCATIONS "J" AND ALONG LONGITUDINAL JOINT (IF ONLY ONE LANE IS REMOVED) FULL DEPTH WITHOUT DAMAGE TO EXISTING CONCRETE. SAW RELIEF JOINTS AS THE ENGINEER DIRECTS OR APPROVES. REMOVE THE EXISTING JPC PAVEMENT TO THE LENGTH AND AT THE LOCATIONS NOTED ELSEWHERE IN THE CONTRACT. L=6 FEET MINIMUM AND LOCATIONS "J" SHALL NOT BE CLOSER THAN 6 FEET TO ANY TRANSVERSE JOINT BEYOND THE REPAIR.
2. INSTALL SMOOTH, LOAD TRANSFER DOWELS (EXCEPT USE TIE BARS FOR SECTION CC), 18 INCHES LONG (SEE STANDARD DRAWING NO. RPS-020 FOR DOWEL SIZE) AT LOCATIONS "J". INSTALL DOWELS (OR TIE BARS FOR SECTION CC) IN THE EXISTING CONCRETE USING EPOXY TYPE IV. INSTALL DOWELS (OR TIE BARS FOR SECTION CC) ON 12 INCH CENTERS BEGINNING 12 INCHES FROM THE EDGE OF THE SLAB.
- ③ IF L IS GREATER THAN 20 FEET, INSTALL NEW LOAD TRANSFER ASSEMBLY(S) AND CONSTRUCT CONTRACTION JOINTS SUCH THAT THE DISTANCE BETWEEN JOINTS IN THE REPLACED SECTION IS NO LESS THAN 10 FEET OR MORE THAN 20 FEET. TRANSVERSE JOINTS SHALL BE SPACED APPROXIMATELY 15' EQUIDISTANT, BUT NOT LESS THAN 10 FEET OR NO MORE THAN 20 FEET. ADJUST JOINTS TO PROVIDE THE MINIMUM NUMBER OF JOINTS WITHOUT EXCEEDING THE 10-20 FOOT RANGE. INSTALL NEW LOAD TRANSFER ASSEMBLY(S) AND ALIGN LOAD TRANSFER ASSEMBLY(S) WITH AN EXISTING JOINT OR CRACK IN THE ADJACENT SLAB IF ONLY ONE LANE IS BEING REPLACED.
- ④ IF ONLY ONE LANE IS REMOVED, AND $L > 25'$, INSTALL NEW 1-INCH TIE BARS 18 INCHES LONG ON 30 INCH CENTERS IN THE LONGITUDINAL JOINT USING EPOXY TYPE IV. IF 2 OR MORE LANES ARE REMOVED, CONSTRUCT LONGITUDINAL JOINT(S) ACCORDING TO THE STANDARD DRAWING EXCEPT USE 1-INCH TIE BARS 18 INCHES LONG ON 30 INCH CENTERS. IF $L \leq 25'$, DO NOT TIE THE LONGITUDINAL JOINT TO THE EXISTING LANE; USE A BOND BREAKER MATERIAL APPROVED BY THE ENGINEER THAT WILL ASSURE NO INTERACTION WITH THE ADJACENT LANE.
5. REPLACE WITH NON-REINFORCED JPC PAVEMENT AND INSTALL CONTRACTION JOINTS AT LOCATIONS "K" AND CONTRACTION JOINTS (OR A CONSTRUCTION JOINT FOR LOCATION CC) AT LOCATIONS "J". SAW AND SEAL ALL JOINTS.
6. SEE "CROSS SECTION" FOR SECTION F.

KENTUCKY DEPARTMENT OF HIGHWAYS
50' JOINT SPACING
SUBMITTED _____ <small>TECH DIVISION OF DESIGN</small>
DATE _____

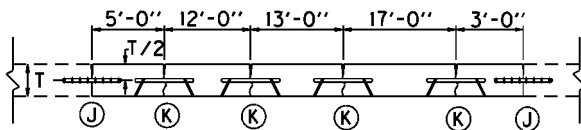
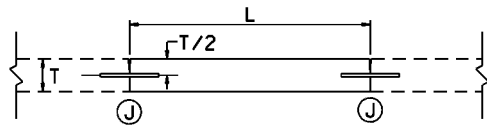
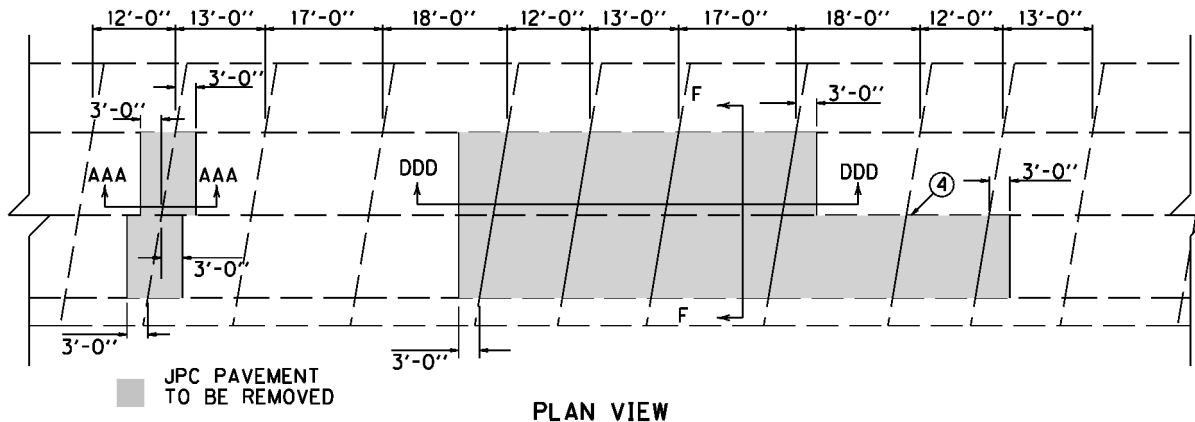

1. SAW AT LOCATIONS "J" AND ALONG LONGITUDINAL JOINT (IF ONLY ONE LANE IS REMOVED) FULL DEPTH WITHOUT DAMAGE TO EXISTING CONCRETE. SAW RELIEF JOINTS AS THE ENGINEER DIRECTS OR APPROVES. REMOVE THE EXISTING JPC PAVEMENT TO THE LENGTH AND AT THE LOCATIONS NOTED ELSEWHERE IN THE CONTRACT. L=6 FEET MINIMUM AND LOCATIONS "J" SHALL NOT BE CLOSER THAN 6 FEET TO ANY TRANSVERSE JOINT BEYOND THE REPAIR.
2. INSTALL SMOOTH, LOAD TRANSFER DOWELS (EXCEPT USE TIE BARS FOR SECTION DDD), 18 INCHES LONG (SEE STANDARD DRAWING NO. RPS-020 FOR DOWEL SIZE) AT LOCATIONS "J". INSTALL DOWELS (OR TIE BARS FOR SECTION DDD) IN THE EXISTING CONCRETE USING EPOXY TYPE IV. INSTALL DOWELS (OR TIE BARS FOR SECTION DDD) ON 12 INCH CENTERS BEGINNING 12 INCHES FROM THE EDGE OF THE SLAB.
3. IF L IS GREATER THAN 20 FEET, INSTALL NEW LOAD TRANSFER ASSEMBLY(S) AND MATCH EXISTING JOINTS. INSTALL NEW LOAD TRANSFER ASSEMBLY(S) AND ALIGN LOAD TRANSFER ASSEMBLY(S) WITH EXISTING JOINTS IN ADJACENT SLABS.
- ④ IF ONLY ONE LANE IS REMOVED, AND $L > 25'$, INSTALL NEW 1-INCH TIE BARS 18 INCHES LONG ON 30 INCH CENTERS IN THE LONGITUDINAL JOINT USING EPOXY TYPE IV. IF 2 OR MORE LANES ARE REMOVED, CONSTRUCT LONGITUDINAL JOINT(S) ACCORDING TO THE STANDARD DRAWING EXCEPT USE 1-INCH TIE BARS 18 INCHES LONG ON 30 INCH CENTERS. IF $L < 25'$, DO NOT TIE THE LONGITUDINAL JOINT TO THE EXISTING LANE; USE A BOND BREAKER MATERIAL APPROVED BY THE ENGINEER THAT WILL ASSURE NO INTERACTION WITH THE ADJACENT LANE.
5. REPLACE WITH NON-REINFORCED JPC PAVEMENT AND INSTALL CONTRACTION JOINTS AT LOCATIONS "K" AND CONTRACTION JOINTS (OR A CONSTRUCTION JOINT FOR LOCATION DDD) AT LOCATIONS "J". SAW AND SEAL ALL JOINTS.
6. SEE "CROSS SECTION" FOR SECTION F.

KENTUCKY DEPARTMENT OF HIGHWAYS
RANDOM SKEWED
APPROVED _____ DATE _____ <small>TEBM DIVISION OF DESIGN</small>

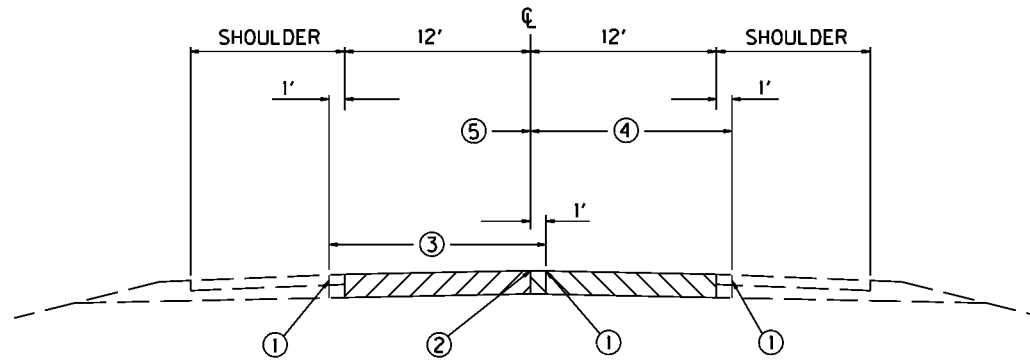

SECTION F

- ① SAW-CUT LINE. THIS ONE FOOT IS TO ALLOW FOR A FORM AND THE REMOVAL AND REPLACEMENT SHALL BE INCIDENTAL TO THE WORK, EXCEPT NEW ASPHALT MIXTURE SHALL BE PAID DIRECT ON A TONNAGE BASIS, AND NEW JPC PAVEMENT WILL BE PAID BY THE SQUARE YARD. COMPACT THE DGA BASE BY MECHANICAL TAMPERS TO THE ENGINEER'S SATISFACTION.
- ② EXISTING LONGITUDINAL JOINT.
- ③ FIRST SLAB REMOVAL LIMITS AND REPLACE 12-FOOT LANE.
- ④ SECOND SLAB REMOVAL LIMITS AND REPLACE 12-FOOT LANE.
- ⑤ THIS ONE FOOT IS TO ALLOW FOR A FORM ON THE FIRST POUR, AND A TEMPORARY PAVEMENT IS REQUIRED. THE DEPARTMENT WILL NOT REQUIRE REMOVAL OF THIS ONE FOOT IF THE GRADE OF THE EXISTING PAVEMENT IS ADEQUATE TO ENSURE THE NEW CONCRETE CAN BE PLACED AND FINISHED TO THE SATISFACTION OF THE ENGINEER. ANY TEMPORARY PAVEMENT IS INCIDENTAL TO JPC PAVEMENT.
6. THE ABOVE DRAWING DEPICTS THE ORDER OF SLAB REMOVAL WHEN BOTH ARE TO BE REMOVED AT THE SAME LOCATION. WHEN ONLY ONE SLAB OR LANE IS TO BE REMOVED, REMOVE AND REPLACE ACCORDING TO SECTION C, CC, OR CCCC. TRAFFIC CONTROL WILL SPECIFY WHICH LANE TO REMOVE FIRST.

KENTUCKY
DEPARTMENT OF HIGHWAYS

CROSS SECTION

APPROVED _____
TECHNICAL DIVISION OF DESIGN DATE _____